

AUTO/MARINE ROCKER Switch

SPST

(On)-None-Off

35-3550

RoHS COMPLIANT

One Seal

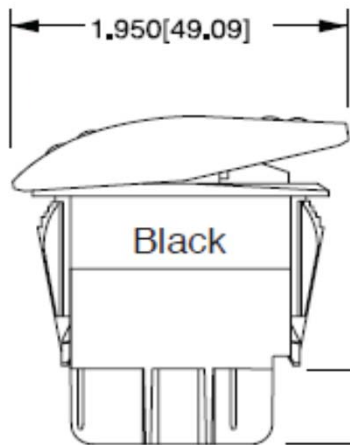
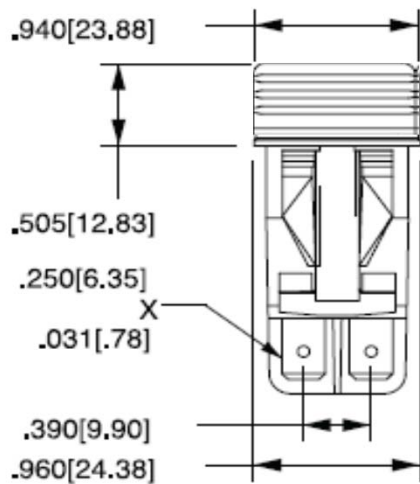

Momentary

Lamp above terminals 1 & 4 end of switch

20A 12V

Red

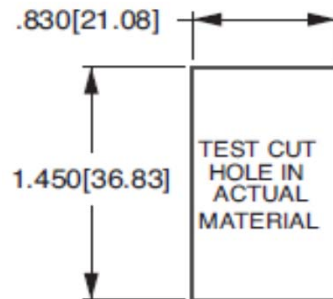
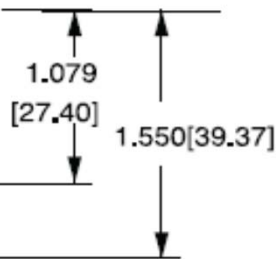

8 TERMINAL BASE W/BARRIERS

Sealed

SWITCH MOUNTING HOLE

Acceptable Panel Thickness

.030 to .109 & .147 to .157

.250 TAB (QC) with barriers

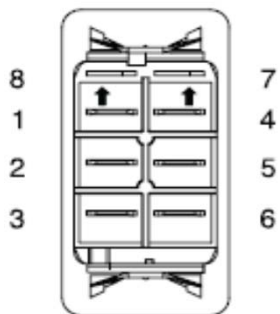

**BOTTOM VIEW
TERMINAL
ARRANGEMENT**

Lamp Terminals 3 & 7

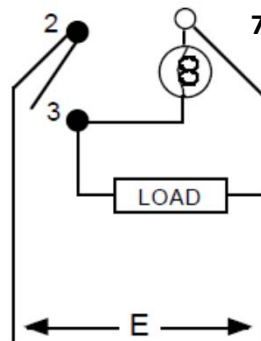

Incandescent

Actuator Lens Down Lit

No legend

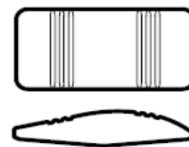

Black
Hard Surface

V2DAB60C-CMC00